

# *PROJETO REDE RNP RS*

- ✓ Início outubro 2013 ( assinatura contrato )
  
- ✓ Projeto dividido em 4 Fases ( upgrades )
  
- ✓ Fase 4 para abril de 2015
  
- ✓ 32 RNPs atendidas no Rio Grande do Sul
  
- ✓ Outras 80 RNPs no restante do país distribuídas em 9 estados
  
- ✓ RNPs pendentes e que serão ativadas até 07/11  
*Cerro Largo, Frederico W., Panambi e Santa Rosa*
  
- ✓ 4 novas RNPs para ativação até dezembro/14  
*Camaquã, Imbé, Gramado e Santa Vitória do Palmar*

- ✓ 105 km de novas redes de fibra lançadas
- ✓ 27 enlaces de rádio ativados
- ✓ 50 switches instalados
- ✓ 14 torres implantadas
- ✓ 11 novos sites
- ✓ equipe técnica ampliada / novas sedes no estado
- ✓ novas rotas de longa distância em ativação ( redundância )

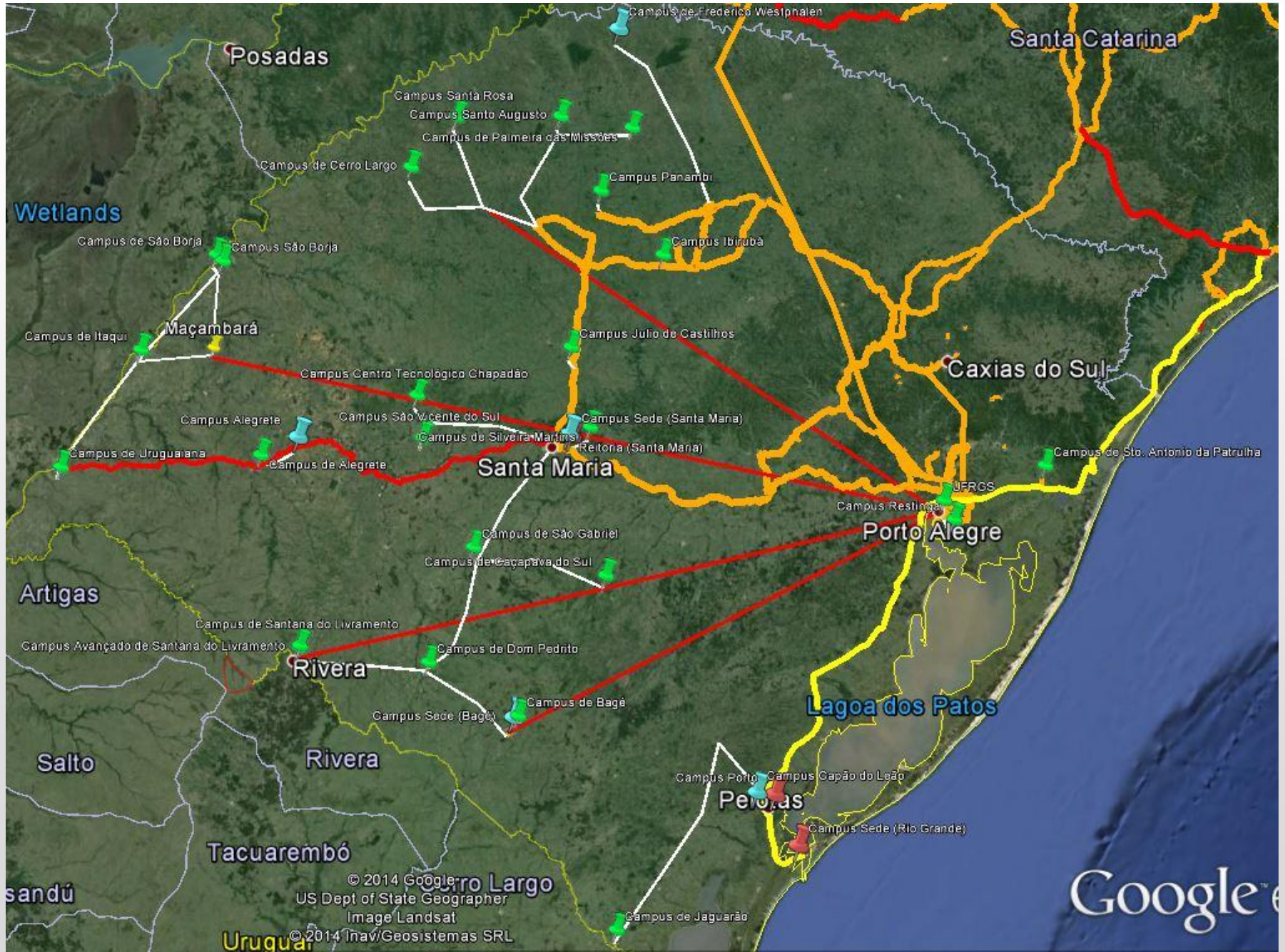



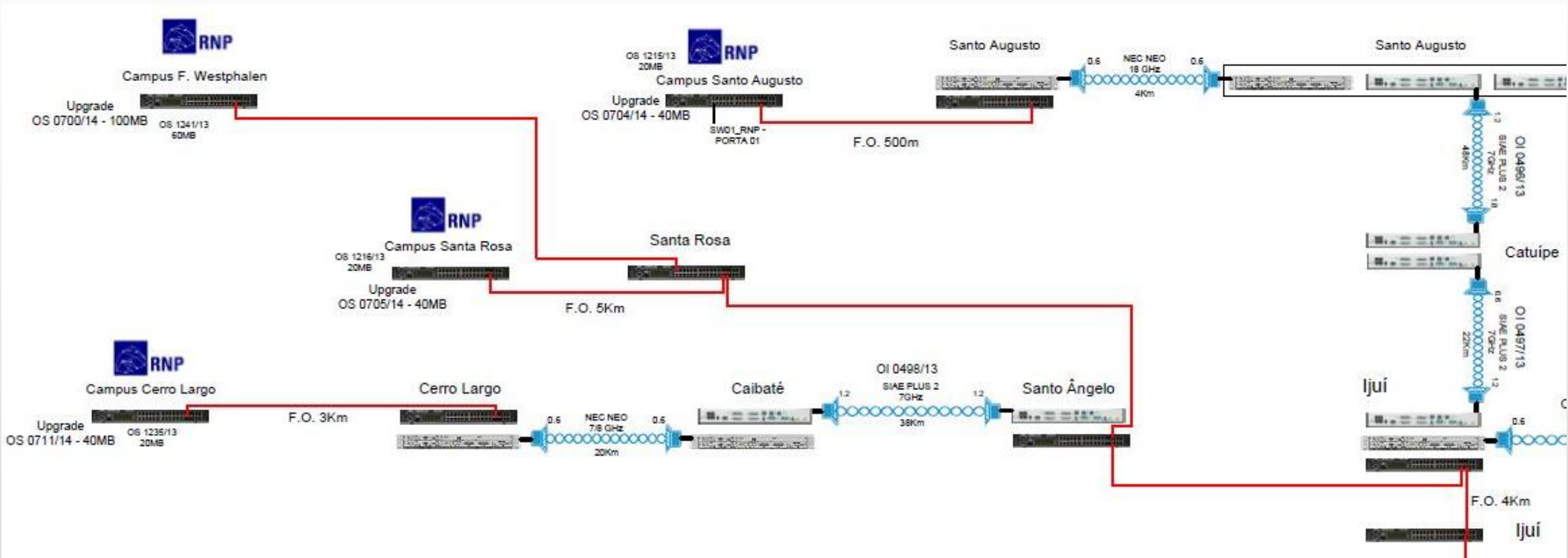

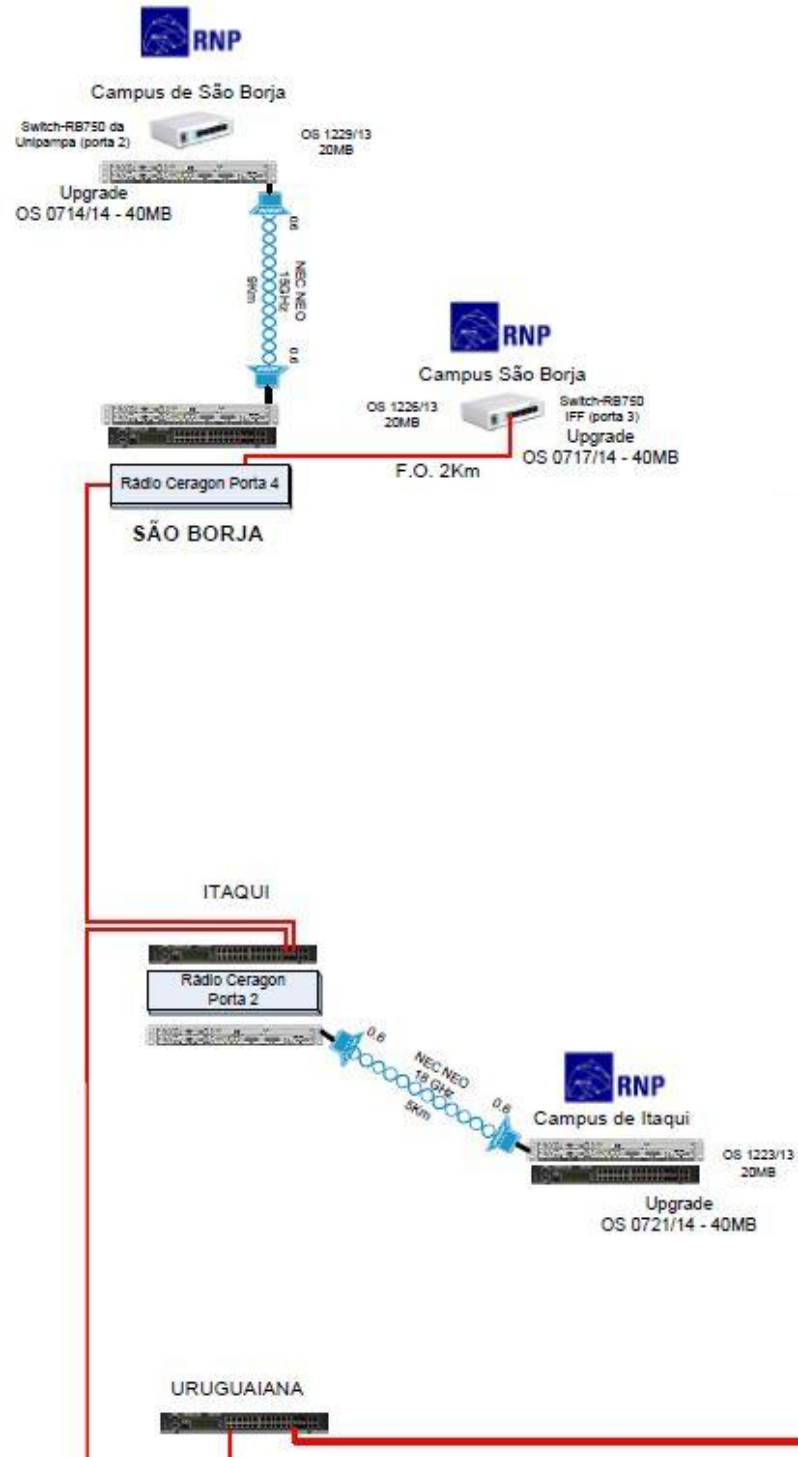

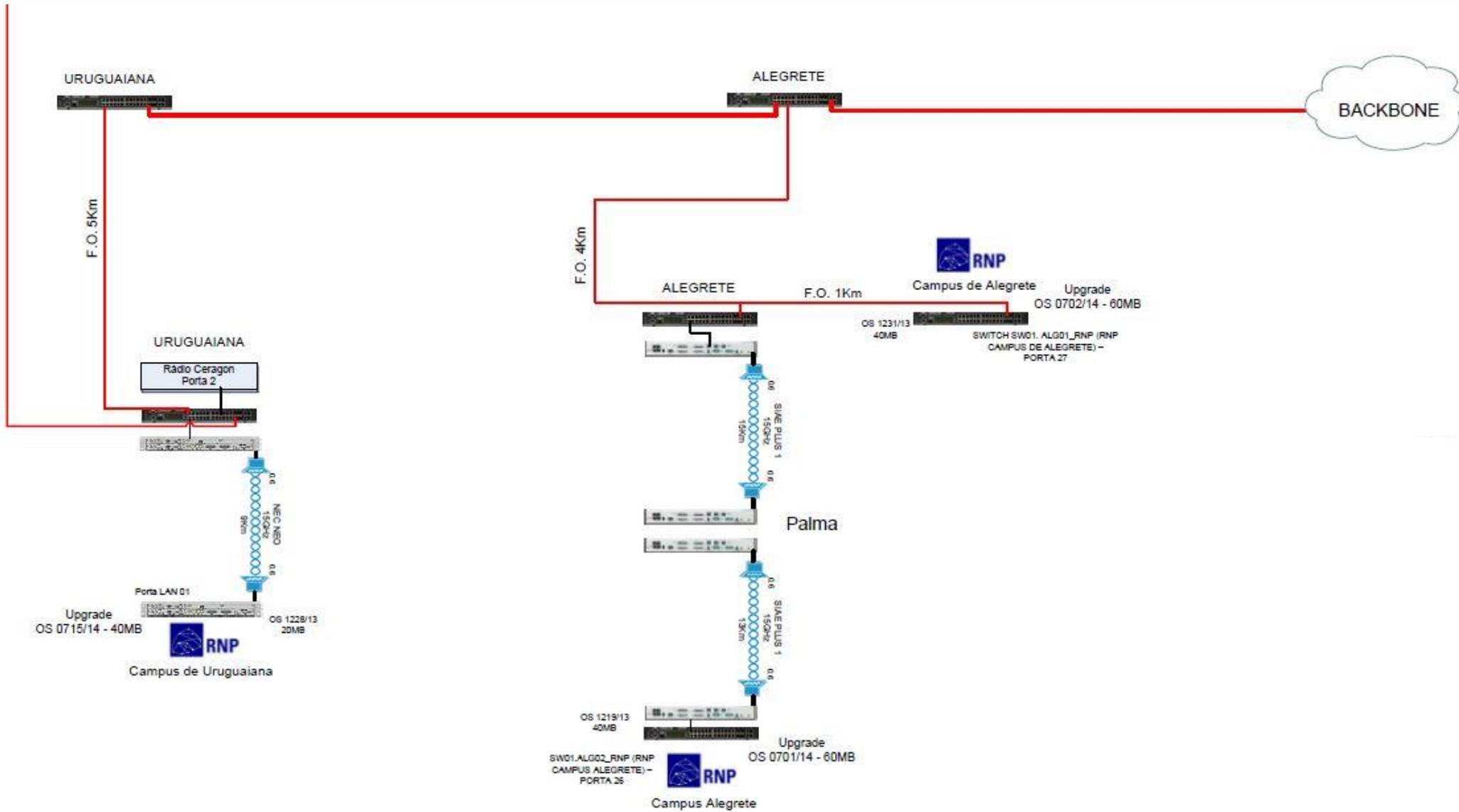



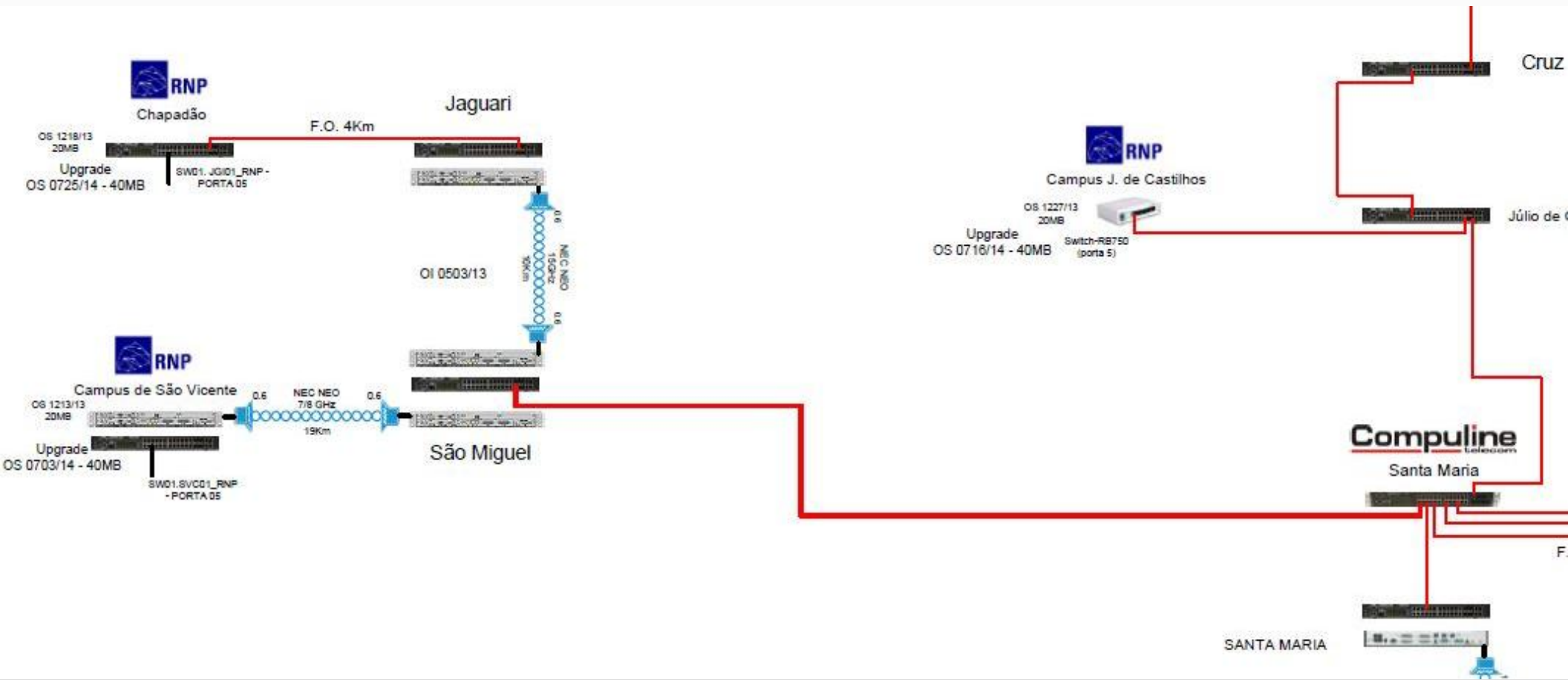

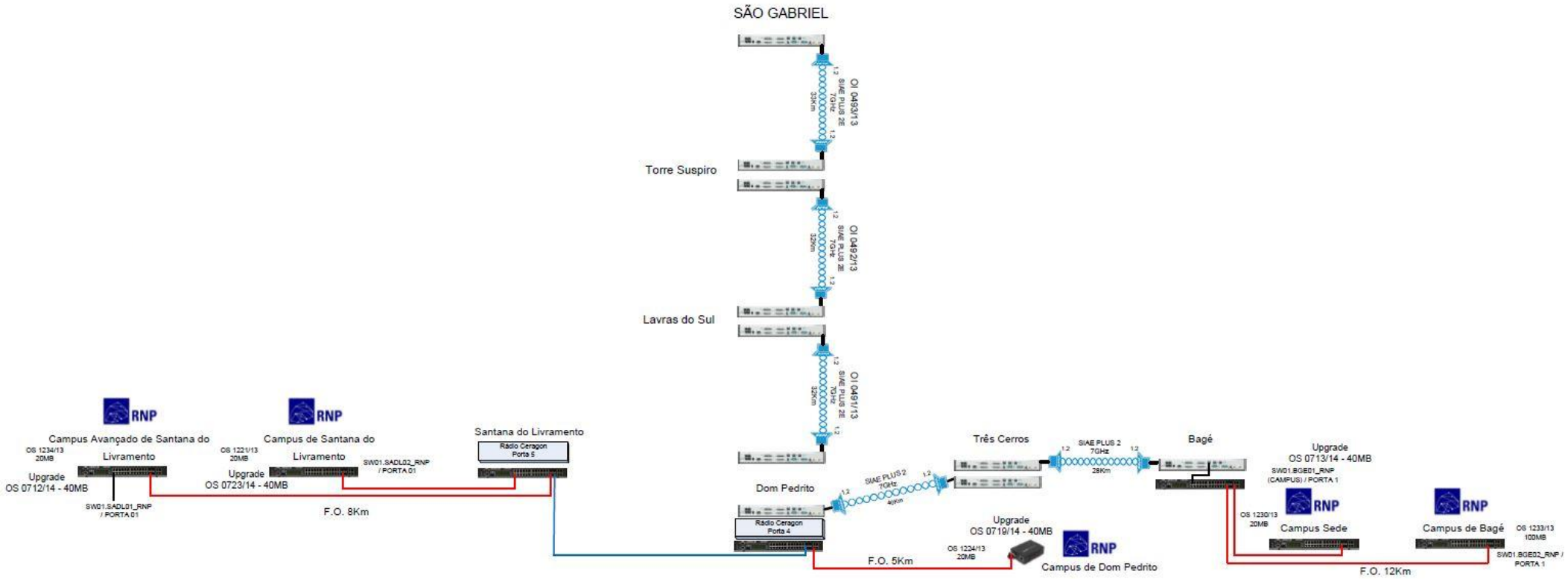

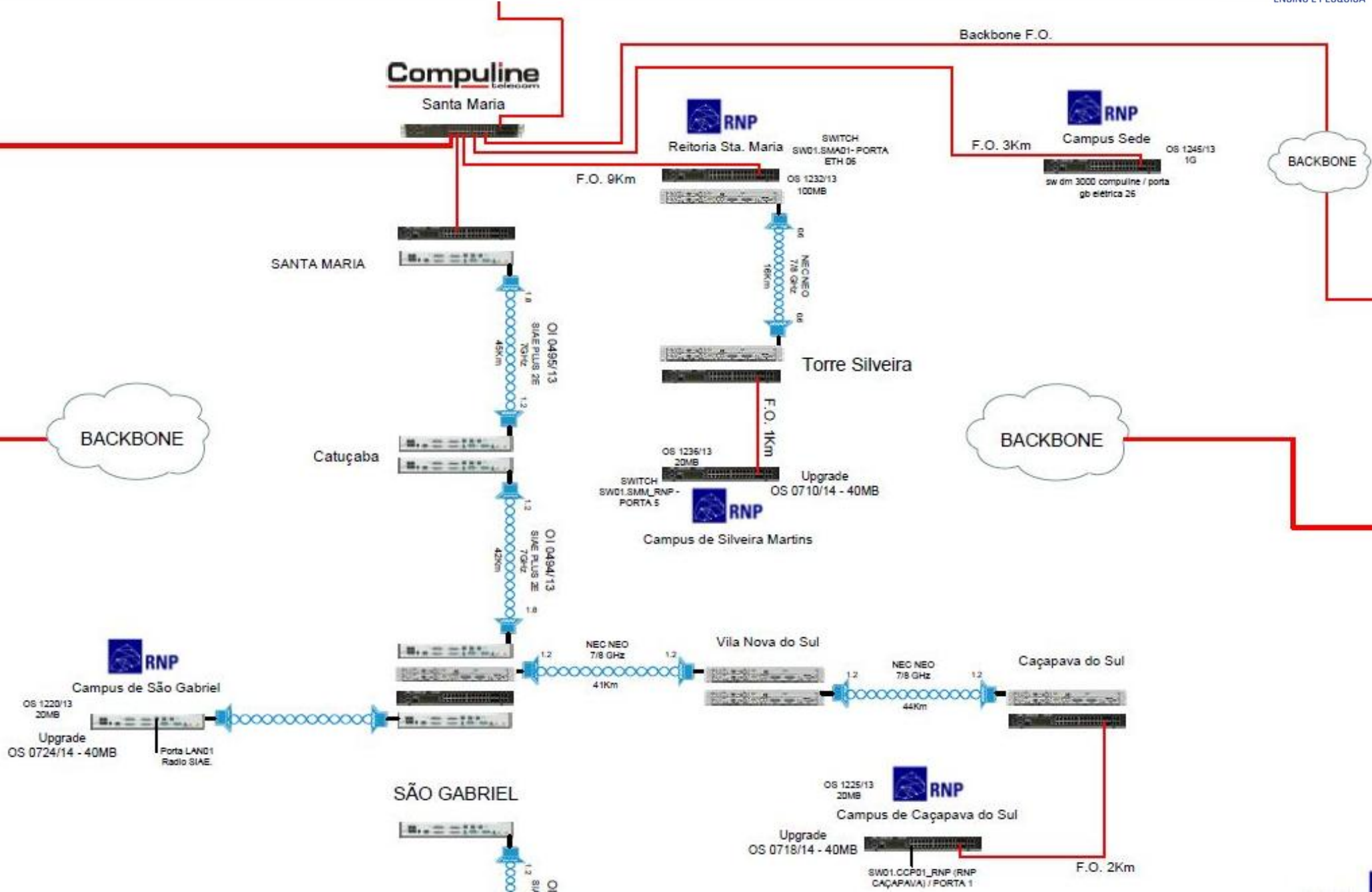

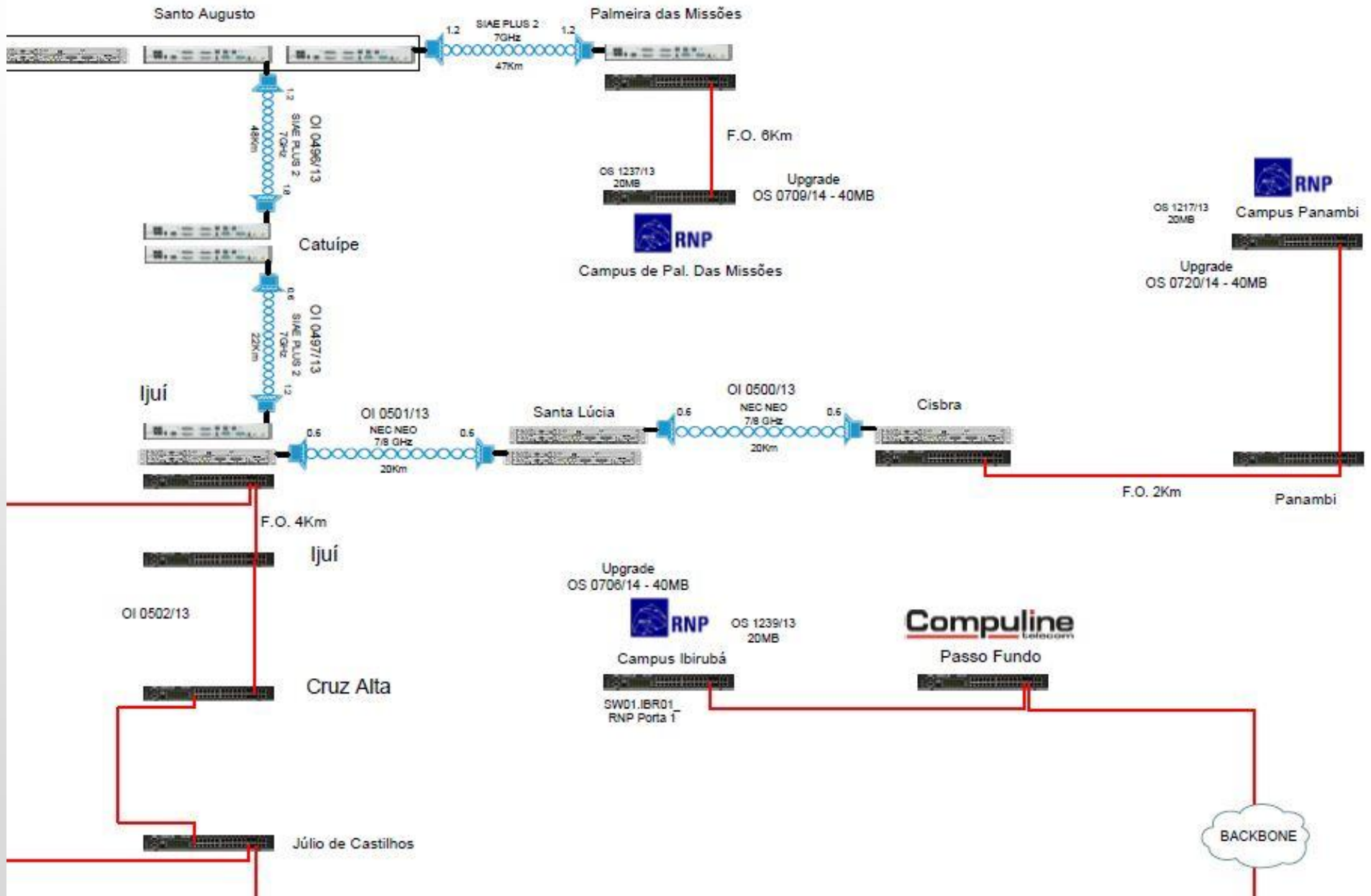

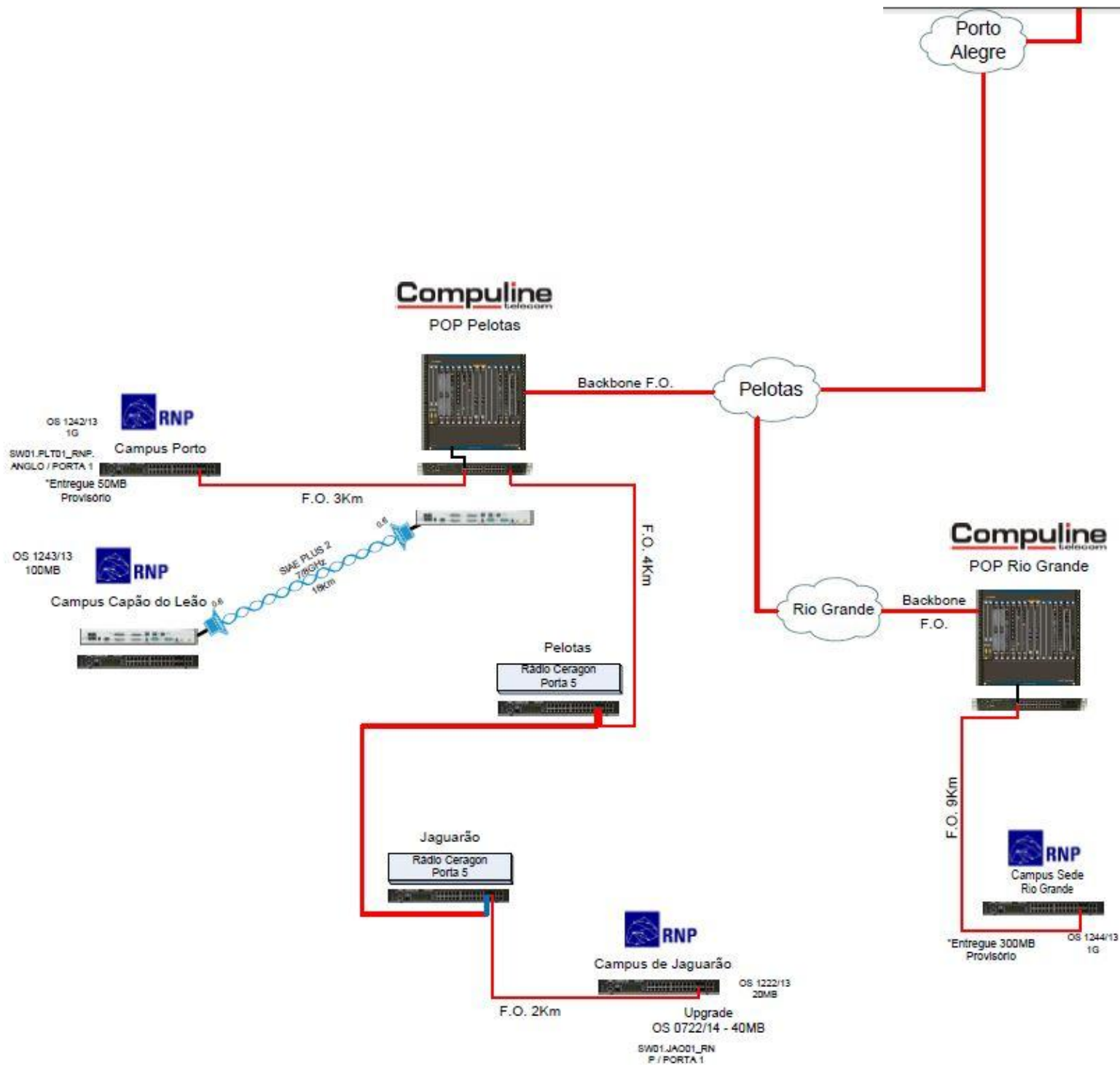

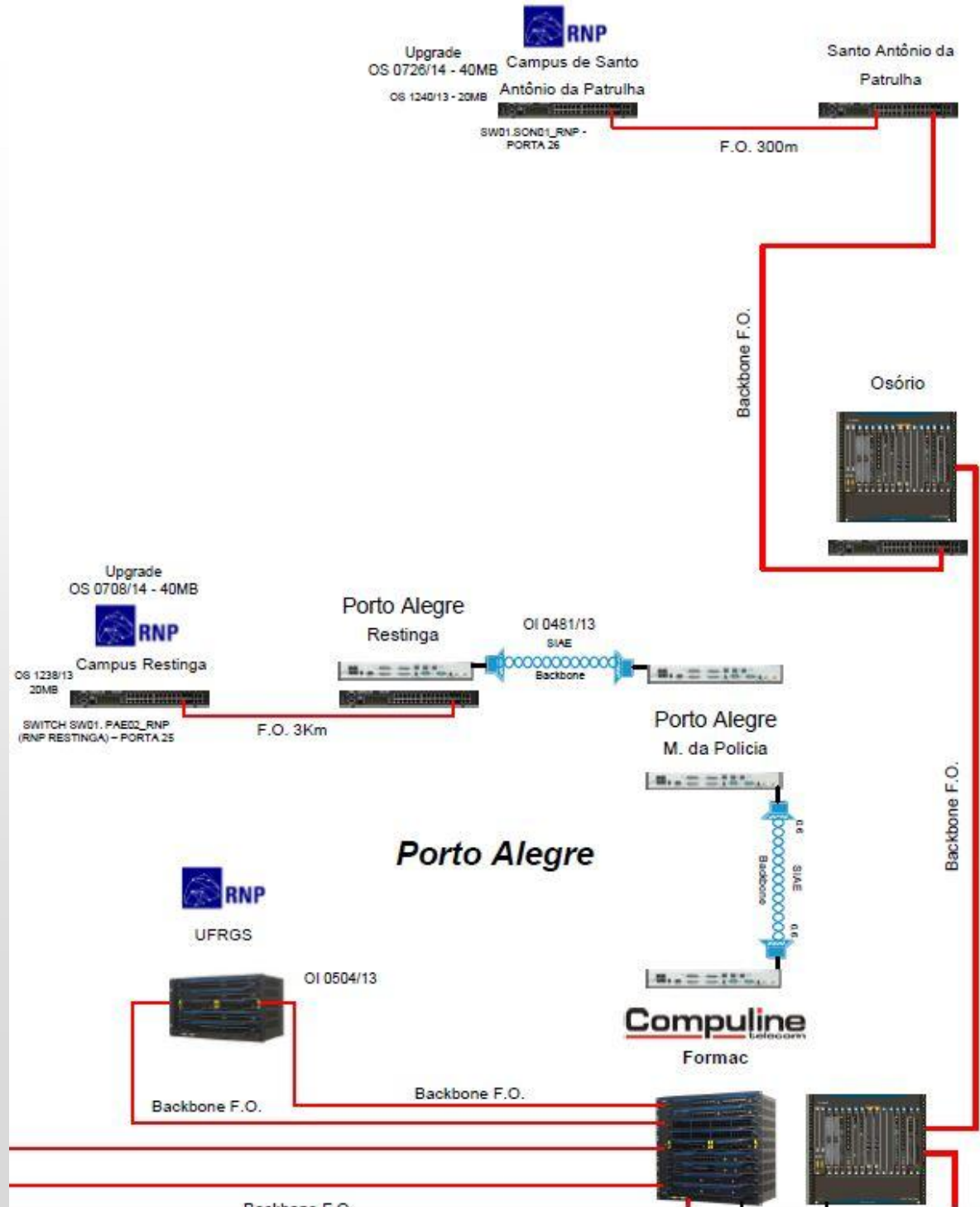

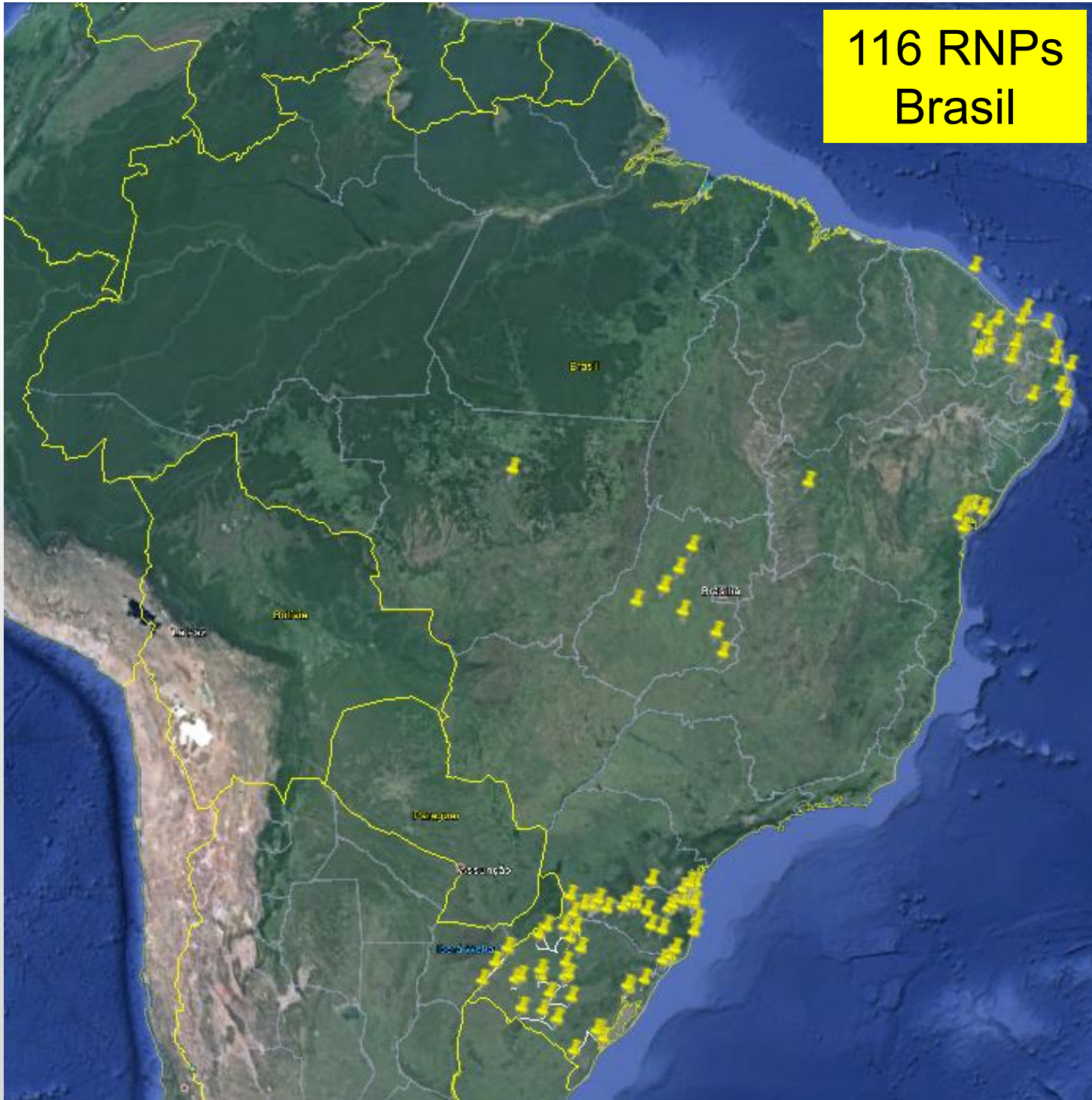

116 RNPs  
Brasil

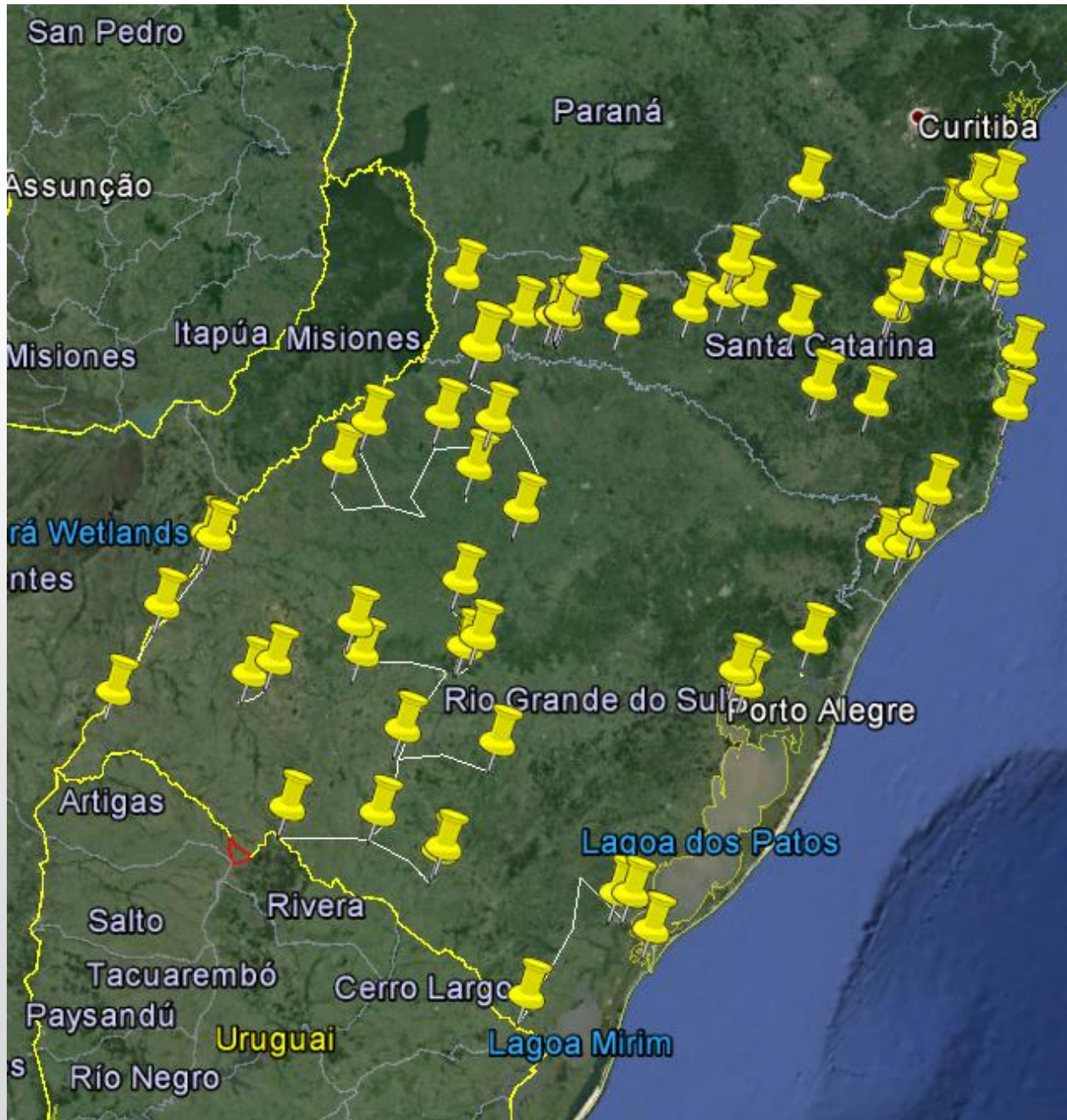



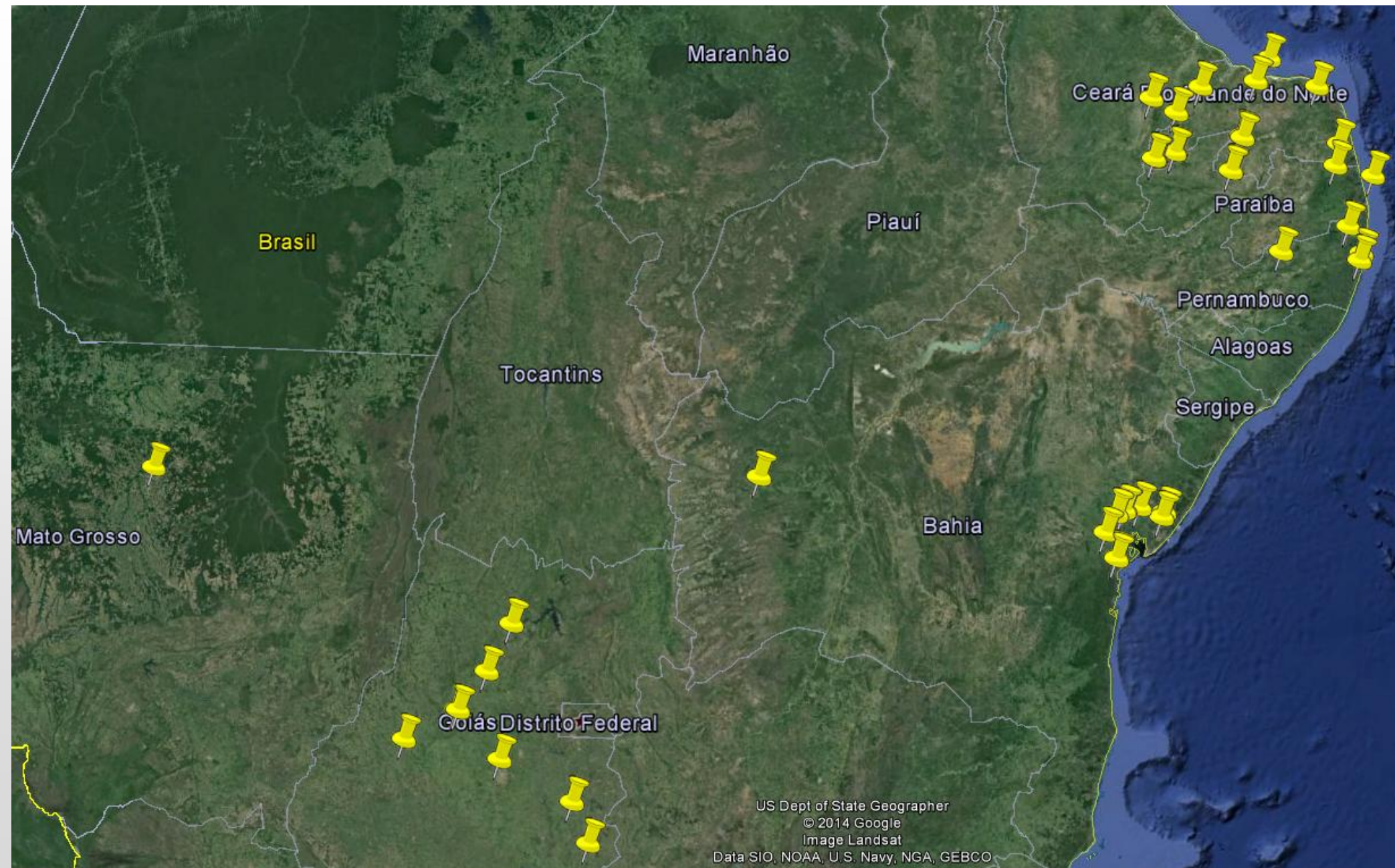

# *Projeto Rede 10Gb / UniDataTI*

RS

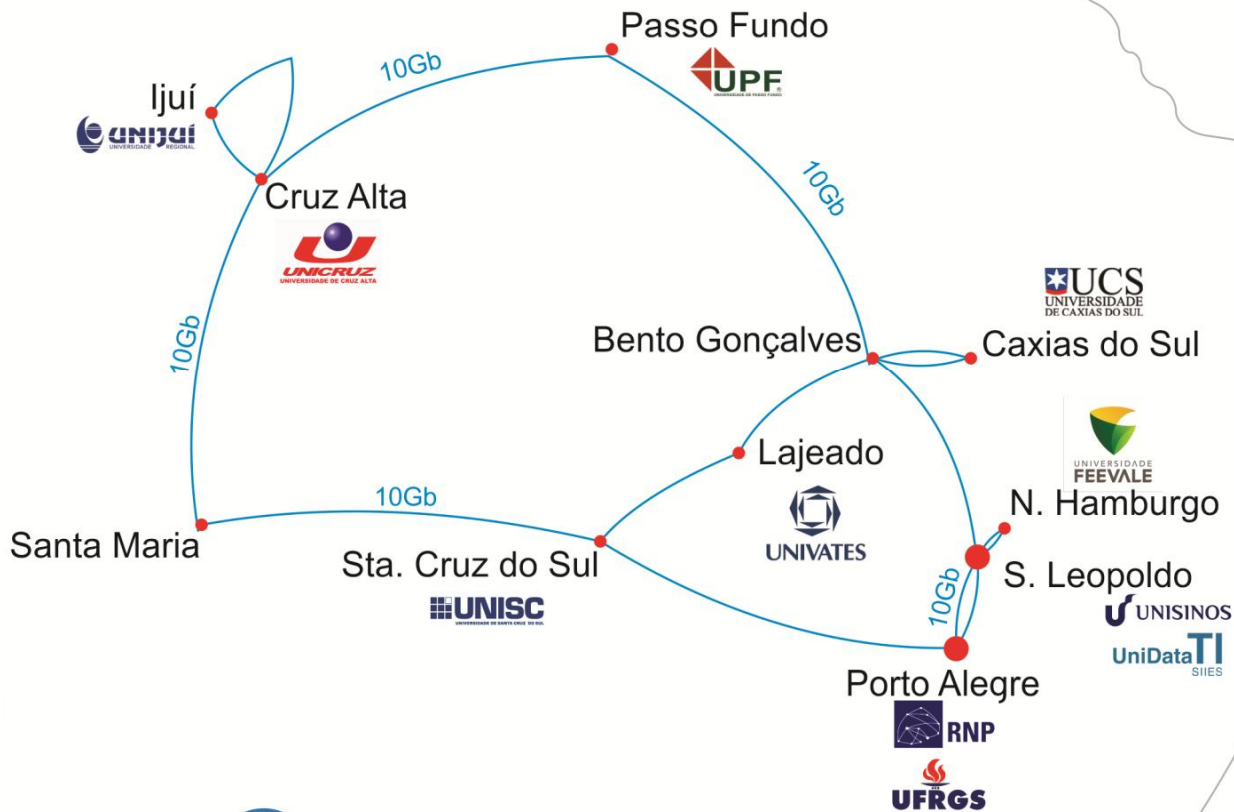

N. Hamburgo



S. Leopoldo



UniData TI  
SIIES



panorâmica diagonal frontal



panorâmica dos fundos



sala tipo



área administrativa



**BR** Digital  
Telecomunicações

